

Non-circular Contouring Measurement for Servo Tuning and Dynamic Performance of a CNC Machine

Charles Wang
Optodyne, Inc.,
1180 mahalo Place
Compton, CA 90220
U.S.A.
310-635-7481
Optodyne@aol.com

Abstract

To achieve high quality and productivity, it is important to know what is the maximum feed rate while meeting the required part accuracy.

Laser interferometers and telescoping ballbars have been used for the positioning and circular contouring measurement. However, a conventional laser is limited by the line-of-sight, and cannot tolerate large lateral deviations. A telescoping ballbar is limited to circular contouring test at low speed and large radius. However, motion errors due to the mistuning of CNC servo control system are often easier to observe on non-circular tool paths.

To make sure that the CNC on the high-velocity machine tools are tuned properly and at its optimum performance, a laser/ballbar is developed by Optodyne to perform circular and non-circular contouring tests. The laser/ballbar is non-contact and not limited to circular contours. By comparing non-circular contouring errors profiles at different feed-rate, motion errors due to mechanical structures, acceleration/deceleration, and those due to CNC servo control system can be identified. The basic theory, test setup, and test results are described.

I. Introduction

In today's manufacturing world, high-velocity machine tools are frequently required to deliver accuracy in the order of a few micrometers, while moving at relatively

high feed rates. The high-velocity machine tools with linear motor can accelerate at 1 to 2 g and can exceed 2000 ipm while cutting contours in five axes. Recently, 5-axis high-precision high-speed milling machines have been developed specifically for die mold applications. To achieve the high precision and super-finishes, static positioning accuracy or repeatability is not enough. The acceptable contour will depend on several factors including cutter path complexity, machine static and dynamic accuracy, the machine acceleration and deceleration rate, the machine control system and compensation, data processing rate, etc. To achieve high quality and productivity, it is important to know what is the maximum feed rate while meeting the required accuracy [1].

A true test of a machine tool performance is whether it can produce fine surface finishes and hold tight dimensional tolerances on corners at high feed rates. That is, whether the CNC is able to anticipate changes in the tool path and adjust the feed rate to account for inertia and inflection points in sharp corners or small radius curves. Inertia can cause the tool to over shoot a turning point and create a distortion. It can shoot past a turn and create a bit of a node on the edge of the corner. Hence, both the undershooting and overshooting phenomena produces out-of-tolerance parts. Also, abrupt changes in feed rates and acceleration can take their toll too. Without appropriate CNC capability and correct tuning, running full bore at high feed rate and acceleration rates can actually create and exacerbate errors.

Laser interferometers [2] and telescoping ballbars [3] have been developed for the positioning and circular contouring measurement. However, a conventional laser interferometer is limited by the line-of-sight. Hence the motion must occur along the laser beam direction. A telescoping ballbar (or double ball bar) is designed to measure the circular contouring accuracy of CNC machine tools and to diagnose their error sources. However, the telescoping ballbar can only perform circular contouring test at low speed and large radius, but motion errors due to the mistuning of CNC servo control system are often easier to observe on non-circular paths.

To make sure that the CNC on the high-velocity machine tools are tuned properly and at its optimum performance, a laser/ballbar [4], is developed by Optodyne, to perform circular and non-circular contouring test. The laser/ballbar is non-contact and not limited to circular contours. For the study here, non-circular contouring tests have been performed using a Laser/ballbar. By comparing with contouring errors profiles at different feed-rate, motion errors due to mechanical structures, and acceleration/deceleration, and those due to CNC servo control system can be identified. The basic theory, test setup, data collection and analysis are described.

II. Telescoping ballbar for circular contouring measurement

A typical telescoping ballbar (double ball bar) device consists of two high-precision balls connected by a telescoping bar, and the distance between two balls is measured by a transducer installed on the telescoping bar.

The telescoping ballbar device is used to measure a contouring error profile as the machine is traversing along a circular trajectory.

The telescoping ballbar circular contouring test provides a rapid and efficient way of measuring a machine tool's contouring

accuracy [5]. This test shows how the two axes work together to move the machine in a circular path. As the machine is traversing with multiple axes along a circular trajectory, each axis goes through sinusoidal acceleration, velocity and position changes. The measured circular path data will show any deviation the machine makes from a perfect circle. The shapes are diagnosed and correlated to servo mismatch, backlash, reversal spikes, squareness error, cyclic error, stick slip, machine vibrations, etc. The diagnosis methodology to identify motion error sources in CNC machine tools based on the telescoping ball bar method was developed by Kakino [3].

However, as point out in [6] that motion errors due to servo control systems are often easier to be identified on non-circular paths. For example, when the proportional gain of the position feedback loop controller does not match between two axes, one can observe a steady state contouring error from a straight-line reference trajectory inclined by 45 degree from one axis. Another example is a contouring error due to the transient response of each axis. It is harder to observe on circular paths.

III. Laser/ballbar setup and operation

The Laser/Ballbar device [4] is based on a single-aperture Laser Doppler Displacement Meter (LDDM) and a flat mirror target. Since a flat mirror is used as target, it can tolerate large lateral displacement. The resolution of the laser system is 0.01 micrometer (or 1 microinch) and the accuracy is 1 ppm. The maximum slew rate is 4 m/sec (160 inch/sec) and the data rate is up to 1000 Hz. This instrument is of a non-contact type with the ability to perform non-circular contours at high feed rate. Using this instrument, the actual feed rate, velocity, and acceleration profiles can also be determined. The hardware used for the test were two MCV-500 laser calibration system with optical adapter; flat-mirror targets, PC interface cards, and a notebook PC with WindowsTM software. As shown in Fig. 1, two laser systems, one pointing in the

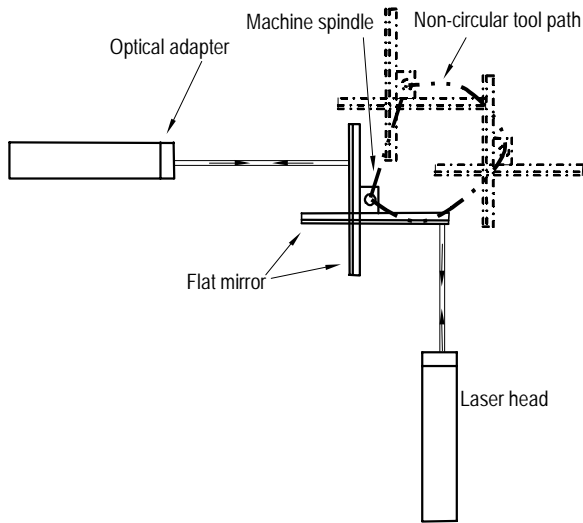

Fig. 1 A typical laser setup for the Non-circular contouring measurement.

x-direction and the other pointing in the y-direction, are mounted on the bed, and two flat-mirrors, one perpendicular to the x-direction laser beam and the other perpendicular to the y-direction laser beam, are mounted on the spindle. As the machine spindle moves along a circular or non-circular tool path, the flat mirrors remain perpendicular to the laser beams and the displacement along the laser beam direction is measured even with large lateral movement. The tool path can be generated by combining the measured displacements in the x-direction and y-direction.

Since the laser/ballbar is non-contact and 2 dimensional measurement instrument, it is suitable for high-speed and high-accuracy non-circular contouring measurement. There is no restriction on the motion to be measured due to a mechanical linkage. Other methods to measure two-dimensional contouring errors include the grid plate [7], which is more expensive and difficult to use.

To separate the machine geometric errors and the servo errors; the noncircular contouring can be measured at two different feed rates. At low feed rate, most of the errors are due to the machine geometry errors and at high feed rate, the deviation

from the low feed rate trajectory is due to the servo error or dynamic errors.

IV. Non-circular contours and test results

Three types of non-circular contours have been performed. The first is a linear movement inclined 45 degree from x-axis. Hence both x-axis and y-axis have to move at the same speed to achieve a 45 degrees straight line tool path. The second is a diamond shape (2 inch square rotated 45 degrees) movement. Hence both x-axis and y-axis have to move at constant speed and reverse directions at the corners. The third is similar to the diamond shape with added half-circles, vertical and horizontal straight lines. Hence there are transitions from linear interpolation to circular interpolations and back.

Linear movement inclined 45 degrees from x-axis

The laser beam was in the 45 degrees from y-axis, the flat-mirror was mounted on the spindle and perpendicular to the laser beam. The spindle was moving along a straight line inclined 45 degree from x-axis. The feed rate was 100 in/min and the data rate was 60 Hz. A typical measured

deviations perpendicular to the movement direction is shown in Fig. 2. The initial spike is due to the servo cut-off frequencies of x-axis and y-axis servo loops, as discussed in [5]

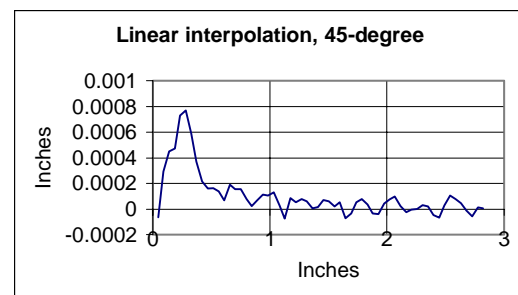

Fig. 2 A measurement lateral deviation of a linear interpolation inclined 45 degree from x-axis.

Diamond shape with linear interpolation

The laser beam was pointing in the x-direction, the flat-mirror was mounted on the spindle and perpendicular to the laser beam. The spindle was moving along a diamond shape tool path. The feed rate was 100 in/min. and the data rate was 60 Hz. A typical measured tool path together with the velocity are shown in Fig.3. The commanded velocity should be a constant at the corners. However, as shown in Fig. 3, the actual velocity at the corners were dropped to 25% at 100 in/min. At lower feed rate, the velocity drop was less.

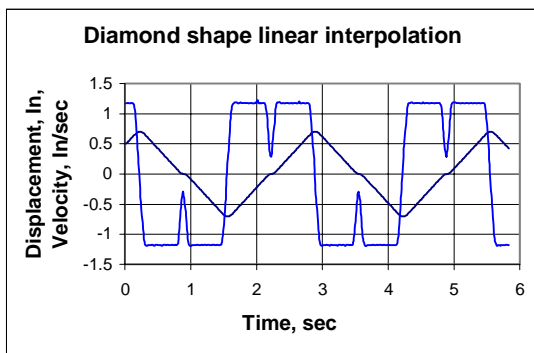

Fig. 3 A diamond shape tool path and its velocity measurement in the x-direction, The velocity dropped to 25% at the corners.

Diamond shape with linear and circular interpolation

Same as the previous setup, but the commanded tool path was a diamond shape with half-circles, vertical and horizontal straight lines as shown in Fig. 4. In this tool

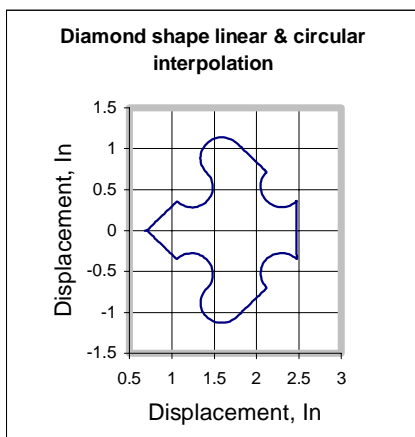

Fig. 4 A diamond shape tool path with half-circles, 45 degree and 135 degrees lines, a vertical and horizontal lines.

path pattern, there are 1, linear interpolation in x-axis, y-axis, inclined 45 degrees and inclined 135 degrees, 2, sharp corners of 45 degrees, 90 degrees, 135 degrees, 3, circular interpolations of half circles along x-axis and y-axis, 4, smooth transitions from linear to circular, circular to circular, circular to linear, and 5, 90 degrees transitions from linear to circular and from circular to linear. At a low feed rate of 10 in/min, the measured tool path, velocity and acceleration are shown in Fig. 5. Here the

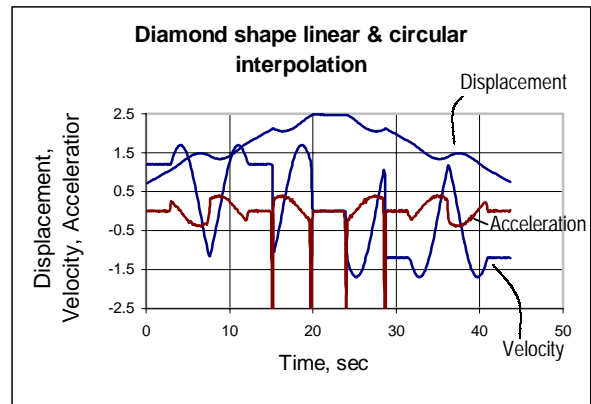

Fig. 5 A diamond (shown in Fig. 4) tool path, velocity and acceleration measured in the x-direction. The feed rate was 10 in/min. The top trace is the displacement(in), the middle trace is the velocity(in/sec) and the bottom trace is the acceleration(in/sec²)

tool path is relatively accurate, almost no velocity drop and the acceleration at corners are relatively narrow. At a higher feed rate of 100 in/min, the measured tool path and velocity are shown in Fig. 6a the acceleration is shown in Fig. 6b. Here the tool path is rounded at corners, the velocity dropped 50% at corners and the acceleration at corners are wide. Most of the errors here were due to the maximum acceleration of the driver. Some of the errors were due to the servo controller and can be used to tune the servo parameters. The above results can also be used to determine the maximum feedrate for certain contours to be within the tolerance.

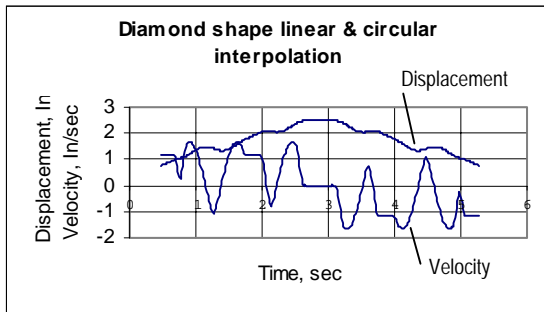

Fig. 6a Same as in Fig. 5, except the feed rate was 100 in/min. The top trace is the displacement (in) and the middle trace is the velocity (in/sec).

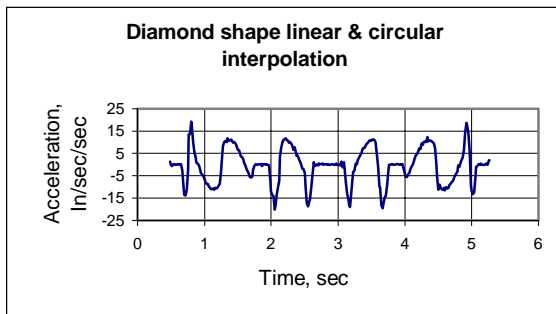

Fig. 6b Same as in Fig. 5, except the feed rate was 100 in/min. The trace is the acceleration (in/sec²).

V. Summary and conclusion

In summary, using Optodyne's Laser/Ballbar system, we have performed the non-circular contouring tests at various shapes at both low and high feed rates. The deviation in the tool path, velocity, and acceleration can be used to determine the contouring accuracy at different feed rate, and for the tuning of servo parameters. Because the measurement is non-contact and with large lateral tolerances, various non-circular contouring accuracy can be measured at various feed rates. The setup time is short, the operation is simple and the data rate is high. It is most suitable for the measurement of non-circular contouring accuracy and servo tuning. Because of these capabilities, the Laser/Ballbar should be an essential tool for servo system, machine tool, and CNC controller manufacture, for optimizing motion-control parameters and contouring accuracy verification.

References

- [1] Omari, M., "Machine dynamics accuracy for automotive die manufacturing", Proceedings of the Second International Advanced Technology for Die and Mold Manufacturing Conference, Oct 16, 1997.
- [2] Wang, C., "Laser Doppler Displacement Measurement," Laser and Optronics, Vol, 6, pp. 69-71, September 1987.
- [3] Kakino, Y., Ihara, Y., & Shinohara, A., "Accuracy Inspection of NC Machine Tools by Double Ball Bar Method, Hanser Publisher, Munich, 1993.
- [4] Wang, C. & Griffin, B., "A noncontact laser technique for circular contouring accuracy measurement", Review of Scientific Instruments, Vol 72, No. 2, pp1594-1596, 2001.
- [5] Circular tests for numerically controlled machine tools, International Standard, ISO 230-4, Test code for machine tools, August 1996.
- [6] Ibaraki, S., Kakino, Y., Lee, K., Ihara, Y., Braasch, J., & Eberherr, A., "Diagnosis and compensation of motion errors in NC machine tools by arbitrary shape contouring error measurement." Proceedings of the LANDMAP 2001 Conference, 2001.
- [7] Heidenhain GmbH, "Measuring Systems for Machine Tool Inspection and Acceptance Testing, Sept., 1997.